



Custom Roll-Up Doors



Hardwood elegance, expertly crafted

We handcraft each Roll-Up Door from the finest hardwoods to your exact specifications.

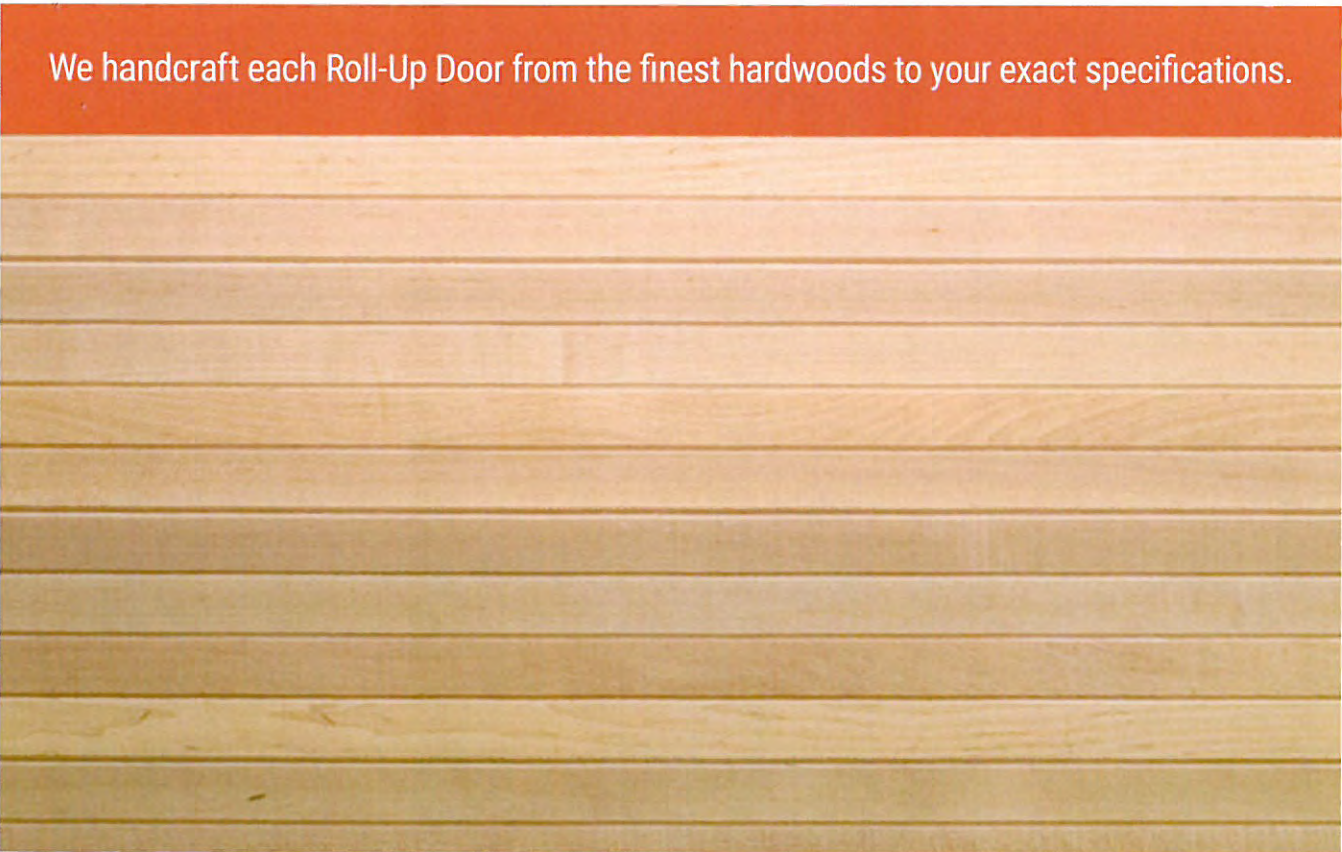

CITY CLERK

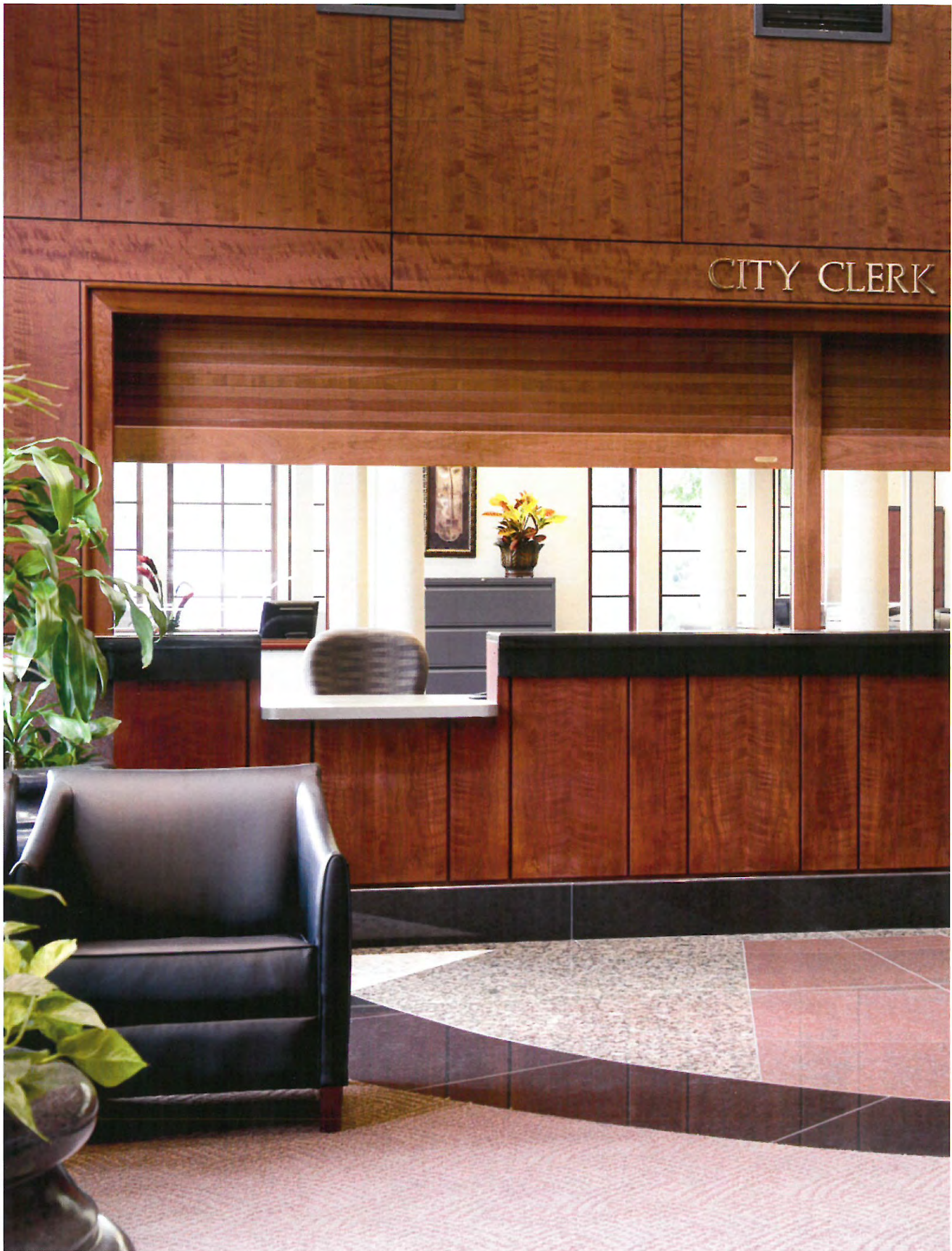



Sophistication and security

Woodfold Roll-Up Doors are available in manual, motorized, or crank operating styles, in nearly any hardwood type. Our truly custom offerings give you options for everything, from mounting styles and latches to wood selection

and the stain or finish for your projects including color matching.

Woodfold interior Roll-Up Doors are not only gorgeous to look at; custom building assures their consistency, precise fits and

tolerances. Our doors' reliability and smooth operation depend on our attention to details, such as using aircraft grade stainless steel cables to tension the assembly for seamless continued operation.



Commercial

- Individually finished by hand
- Finest hardwoods, custom matching
- Custom built
- Manual, crank or motorized operation
- Can be fully finished to match your existing stains/finishes

Hospitality

- Most hardwoods available to match
- Stained or painted
- Hand assembled
- Matched to your existing interior
- Each door is tested before shipping

Security and Retail

- Shipped fully finished
- Custom crafted
- Built to suit each opening
- Warranted against manufacturing failures
- 100% made in the USA
- Three week manufacturing lead time from order acceptance





A Stylish Statement

Why choose a Roll-Up Door?



Roll-Up Doors are the perfect answer for closing off or securing customer service windows and service areas. They reach from counter-height or from the floor, upward, without using any precious floor space: our Roll-Up's entire mechanism is installed overhead,



out of the way. While many metal versions are available elsewhere, when you choose a hardwood Roll-Up Door from Woodfold, you add style and grandeur to hospitality installations such as bars and restaurants; or refinement and security to commercial installations,



such as banks or government offices; or even a splash of luxury to a residence by camouflaging a wall-size entertainment center or creating a glorious treatment for a kitchen pantry or laundry.



See more options at
www.woodfold.com







Custom Roll-Up Doors

Woodfold is your Roll-Up choice



Simply put, our distinctive Roll-Up Doors are the finest available. We are a leading manufacturer of hardwood roll-up doors, starting each order with magnificent, hand-selected Northern Red Oak, Eastern Maple, Natural Birch, African



Mahogany, or American Cherry. We've been in the woodcrafting business since 1957, so our expert craftsmen use their years of experience to build with precision. Every piece of every door is individually finished prior to assembly



in order to assure flawless coverage. Woodfold Custom Hardwood Roll-Up Doors are available through a variety of specialty door and architectural product distributors/installers in the United States, Canada, UK, Australia, and select other countries.



We also use FSC® woods (license number: FSC-C021909).



For more details, or a local distributor, contact us at **503.357.7181**.



Highlight or hide



Hospitality Venue Enhancement

Assignment: A luxury hotel wanted to improve its customer service by being able to separate its low-key breakfast dining area from the noisy kitchen, as well as from the after-hours sports bar.

Our Solution: With the addition of a series of one-of-a kind Roll-Up Doors, the hotel's kitchen staff is now able to prepare meals without disturbing guests, then raise the doors when ready to serve. The sports bar remains demurely concealed when not open for business. Custom staining for this project created a perfect match with the hotel's rich woodwork and furnishings.



Customer Service Space

Assignment: A business with a customer service office wanted a way to reduce its visual distraction from an adjacent area, when the service desk was closed for the day.

Our Solution: Woodfold's motorized ceiling-to-floor Roll-Up Door provided an easy and architecturally elegant way to separate this office space from a public lobby, and will assure lockable security whenever the office is closed.



Hospitality Venue Security

Assignment: An upscale bar needed to minimize the time and labor involved in setting up and closing operations each day. Reducing theft was also a key objective.

Our Solution: By installing a series of Woodfold's lockable Roll-Up Doors, the business does not need to set up its bar stock every day and remove it every night—bottles, glassware, and displays can remain in place and ready for the next business day. New lockable, custom-stained hardwood doors were matched to the bar's existing millwork, and reduce costly inventory loss.









Transforming space and access



Our exceptional hardwood doors add functionality to rooms such as kitchens and service desks that require restricting access part of

the time. When food service or office hours are over, simply roll down a Woodfold door to prevent access to one area, while still

making the room available for other purposes. Out of sight, the covered space can be prepared for its next use, to be instantly ready.



Read about Roll-Up options at www.woodfold.com



Technical details

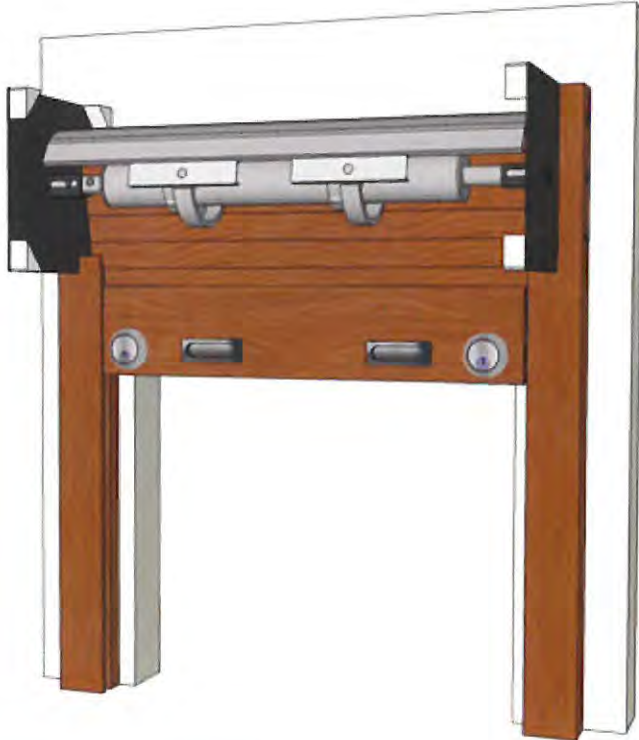

Architectural Specifications

Woodfold Roll-Up Doors are upward coiling and factory finished (unfinished available). Individual slats are interconnected using plastic coated, aircraft-grade stainless steel cables that are fixed at top and bottom. Woodfold Roll-Up Doors' overhead coiling system uses manual, awning crank, or electric motor driven operation. All necessary hardware and materials are included for normal installation.

Roll-Up Door Product Specifications

For complete product specifications, please visit www.woodfold.com/specs.php

- **Materials:** Curtain, Hood, Fascia and Guide Rails available in Birch, Cherry, Mahogany, Maple and Oak. Additional hardwoods available.
- **Operation:** Manual, Motorized or Crank.
- **Finish:** Clear Finish, Custom Stain, Custom Paint or Unfinished.
- **Latch:** Keylock, Thumbturn or Slide bolts.
- **Component Dimensions:** Curtain slats 1/2" x 1-1/2".
- **Bottom Bar:** 1-5/8" x 5".
- **Width:** Up to 12'-0".
- **Height:** Up to 8'-0".
- **Weight:** Installed Weight is approximately 10 lbs. per Square Foot.

Mechanical Options



Awning-Style Mechanism provides ease of operation on large Roll-Up Doors.

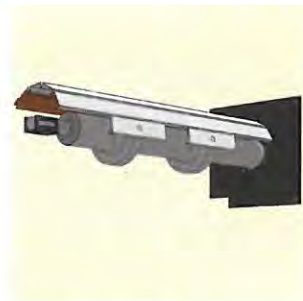

Tubular Motor provides conventional automatic operation on large Roll-Up Doors.

For Architects and Specifiers:

We are compliant with Division 8 in the major specifier directories and also have BIM files on our website.



See all mounting options at www.woodfold.com/roll-up



Mounting options



Inside Mount Under Lintel

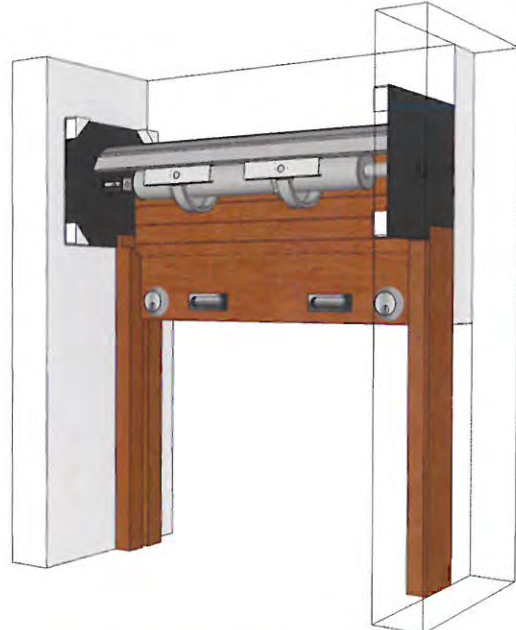

Between Wall Mount on Face of Lintel

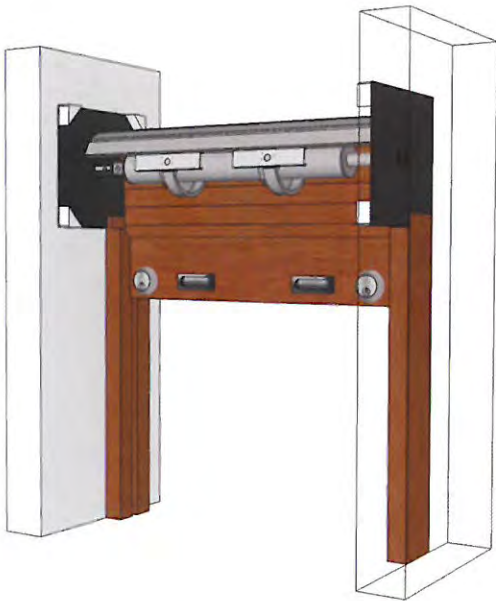

Between Wall Mount Without Lintel

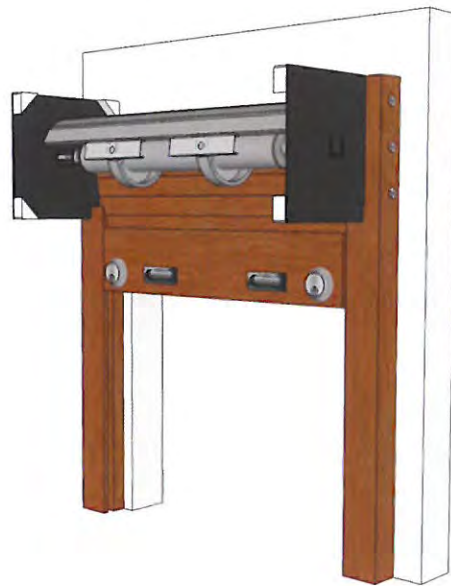

Outside Mount







Finishing touches

While it's our woodworking process that sets Woodfold custom Roll-Up Doors apart, you'll also appreciate the absolute consistency of our factory finish.

Our use of the finest natural hardwoods enables us to apply

rich, gorgeous finishes. While some manufacturers finish a product once it's been assembled, we finish each piece before assembly, for consistently beautiful wood—from any angle. Choose from factory finished clear lacquers or custom

stains and/or paints that match your existing millwork or décor. All factory clear coat finishes are designated Sherwin Williams GreenSure products.



Solid Paints

We typically match

- Sherwin Williams
- Benjamin Moore

We can work with almost all water-based paint manufacturers

- We will match your palette using our craftsmen and technology

Hardwood Options

Woodfold Roll-Up Doors are custom-crafted of the finest natural hardwoods, including:

- Northern Red Oak
- Eastern Maple
- Natural Birch
- African Mahogany
- American Cherry

We can also build our Roll-Up Doors in nearly any other hardwood you'd prefer. Simply talk with your distributor, or call us directly.

Available in FSC® Certified Woods

Woodfold is certified to manufacture and sell FSC® hardwood Roll-Up Doors. FSC® products may be used toward LEED® credits and other green building programs that require certified sustainable wood products.



Ask about our FSC® certified material (license number: FSC-C021909).

Printed colors in this bulletin will vary from actual wood stain colors.



Read more about our work in the Northwest at www.woodfold.com



Crafting Value For More Than 60 Years

The Woodfold story

Our work reflects the way we live



We work lean

At Woodfold, we've embraced Lean Manufacturing, making better use of our space, precious raw materials, and each person's time. It's a constant process of improvement that ensures consistent quality.

Today we have the flexibility in our manufacturing processes to ensure the detail of hand finishing while maintaining the speed and flexibility of modern assembly and quality control.



We work clean

Monitoring and minimizing our impact on the environment has always been an important part of the Woodfold culture. One example is our conversion to water-based paints and stains that don't compromise on quality. As an employee-owned company, we take great pride and personal ownership in protecting the community in which we live.



We do the right thing

At Woodfold, we operate with the fundamental belief in doing the right thing, like using wood from sustainable forests in our products. As an employee-owned company, we strive to make a positive impact on our people, our community and the environment by increasing recycling, reducing waste, reducing our carbon footprint, and relentlessly reviewing how we can do better.



100% designed, sourced and manufactured in the USA by owner employees.



Connect

@WoodfoldMfg

@WoodfoldMfg

www.woodfold.com

woodfold@woodfold.com

Woodfold Manufacturing

1811 18th Avenue
Forest Grove, OR 97116
Call us at 503.357.7181